

**AEGIS® PRO Ring for
WIND TURBINE SHAFT GROUNDING**
**Double Inverter Fed
Wind Turbine Generator**
Best Practices for Bearing Protection



AEGIS® PRO Ring for Wind Turbine Generator Shaft Grounding Provides Both Contact and NanoGap Grounding



AEGIS® PRO Ring uses Revolutionary Nanogap Technology

- Unique contact/non-contact design
- 360 degrees circumferential conductive micro fiber ring
- 6 rows of fiber – greatest reliability
- Ensures unmatched shaft grounding and performance



The AEGIS® Shaft Grounding Ring's patented NanoGap Technology ensures effective electrical contact even when physical contact is broken. Only AEGIS® Nanogap Technology provides both maintenance-free contact and non-contact bearing protection for the normal service life of the motor's bearings as well as the most reliable operation of any shaft grounding technology.

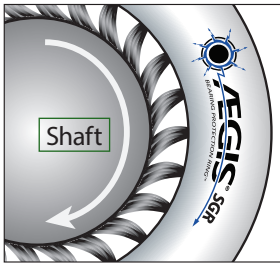

Specially Designed Microfibers Flex Without Breaking

Designed with specific mechanical and electrical characteristics that minimize wear and maintain conductivity, AEGIS® microfibers will last for the life of the motor. Based on wear of less than 0.001" (0.025mm) during 10,000 hours of testing, proven to withstand over 200,000 hours of continuous operation.

Through our patented design, AEGIS® conductive microfibers exhibit minimal wear and the ability to flex without breaking. In testing, they were proven to withstand 2 million direction reversals (to 1800 RPM) with no fiber fatigue or breakage.

AEGIS® Rings are designed with an optimal fiber overlap to the shaft of 0.030" (0.76mm).

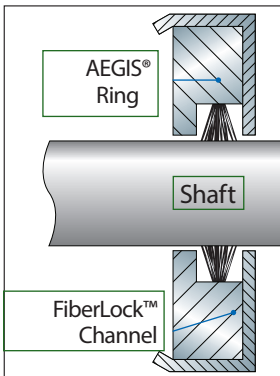

Patented FiberLock™ Channel Secures and Protects Fibers

AEGIS's patented, protective FiberLock™ channel locks the ring's conductive microfibers securely in place around the motor shaft, allowing them to flex without breaking. The channel also helps protect the fibers from excessive dirt, oil, grease, and other contaminants.

Current Capability

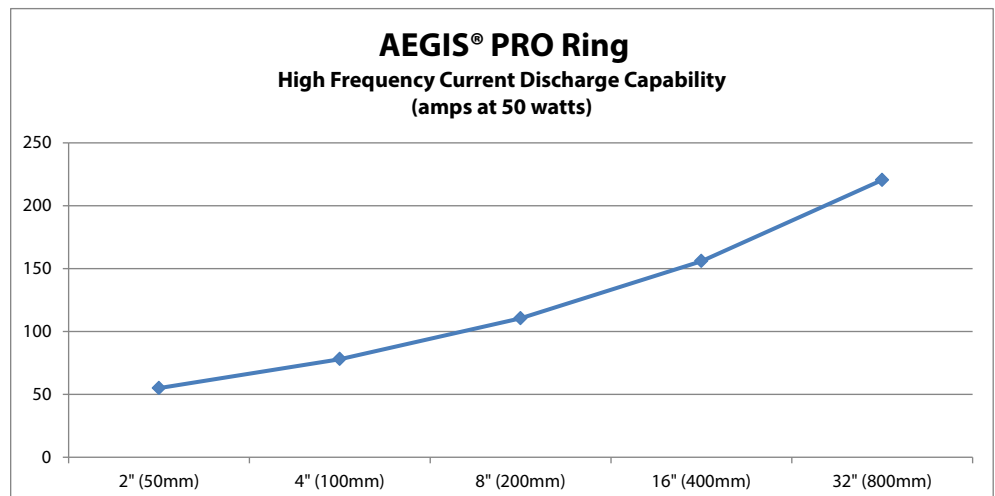

AEGIS® PRO Ring for Wind Turbine Bearing Protection

- Safely channels harmful shaft voltages to ground
- Help protect wind turbine generators from catastrophic bearing failure
- Proven design - Engineered for any size wind turbine generator



PROBLEM: Shaft Currents Damage Wind Turbine Generators

Induced shaft voltages, which can measure as high as 2200 volts peak to peak, are present on the shaft of wind turbine generators. These voltages can cause high frequency bearing currents over 60 amps, which result in pitting, fluting and catastrophic bearing failure. Turbine failures cost tens of thousands of dollars in system down time, repairs, and lost revenue.



SOLUTION: AEGIS® PRO Ring - Bearing Protection Ring

AEGIS® PRO Ring Bearing Protection Rings help protect wind generator bearings from catastrophic failure. Tested up tower, the specially engineered Bearing Protection Ring is capable of channeling high frequency voltages and currents safely away from the bearings to ground. Generators and gear boxes are protected ensuring greater system reliability and up time.

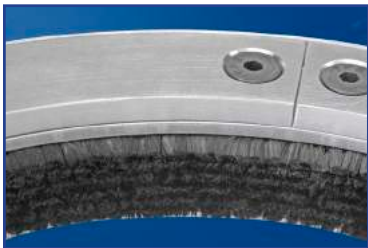

6 Rows of Proprietary Conductive Microfiber

The AEGIS® PRO Ring Shaft Grounding Ring's unique design features hundreds of thousands to millions of specially engineered conductive microfibers that encircle the motor shaft. With so many electrical transfer points the ring provides continuous electrical contact, whether its fibers are physically touching the shaft or not. This patented "NanoGap" technology enables both contact and non-contact shaft grounding — 100% of the time. Six rows of conductive microfiber ensure high current flow.

Fits all wind generators including:

ABB	Marathon
Alstom	Suzlon
Elin	Teco
Gamesa	Toshiba
GE	VEM
Hitachi	WEG
Leroy-Somer	Weier
Loher	Winergy

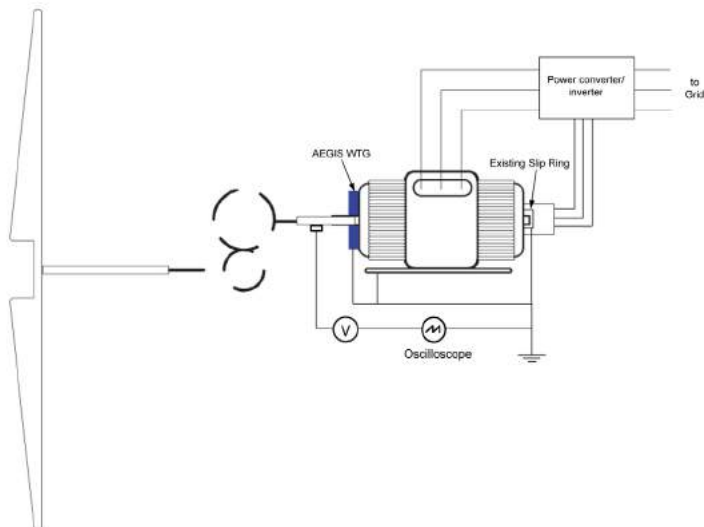

Up-Tower Testing - Double Inverter Fed Wind Turbine Generator

AEGIS® PRO Assembly used for Testing

1. Non-conductive isolation mounting bracket with spacers
2. AEGIS® PRO Ring
3. AEGIS® Monitoring Ring – used to measure shaft voltages (or use AEGIS® SVP)
4. AEGIS® CS015 Colloidal Silver Shaft Coating on shaft surface
5. High frequency grounding cable (used in testing setup only)

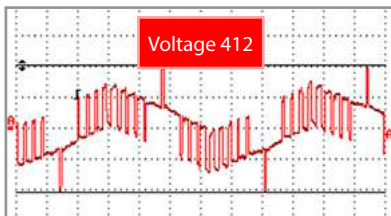
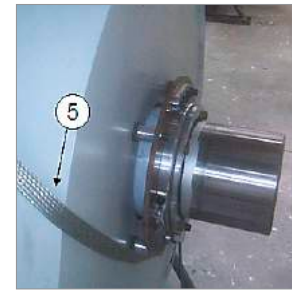
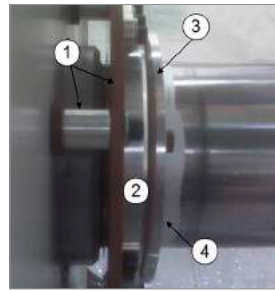

No Shaft Grounding

Reading 1
Volts: 412 V pk-pk
1500 RPM

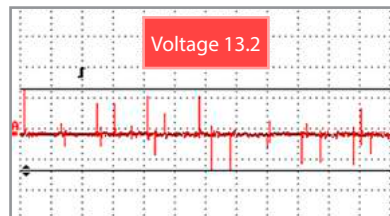

SR Carbon Brush Only

Reading 1
Volts: 13.2 V pk-pk
1500 RPM

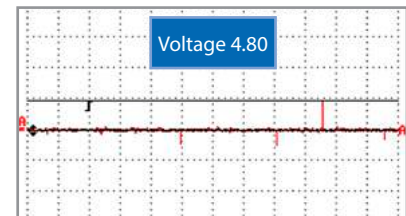

AEGIS® PRO Installed

Reading 1
Volts: 4.80 V pk-pk
1500 RPM

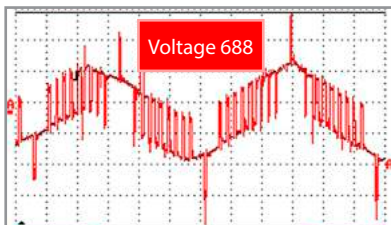

No Shaft Grounding

Reading 2
Volts: 688 V pk-pk
1800 RPM

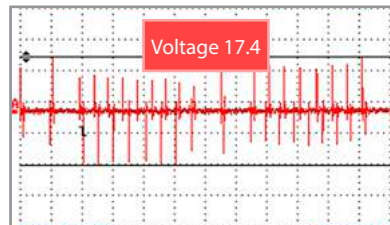

SR Carbon Brush Only

Reading 2
Volts: 17.4 V pk-pk
1800 RPM

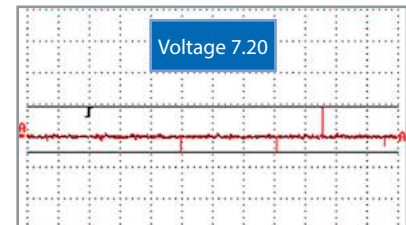

AEGIS® PRO Installed

Reading 2
Volts: 7.20 V pk-pk
1800 RPM

- Shaft voltage test conducted with the generator shaft ungrounded.
- AEGIS® PRO Ring ground disconnected on DE, SR carbon brush removed from brush holder on NDE.
- Shaft voltage measured on the drive end using the AEGIS® monitoring ring as the voltage pick-up.

- Shaft voltage test conducted with the generator shaft grounded by the SR carbon brush on the non-drive end. AEGIS® was disconnected on the DE.
- Shaft voltage measured on the drive end using the AEGIS® monitoring ring as the voltage pick-up.
- Observed high frequency voltages on the shaft.

- Shaft voltage test conducted with the generator shaft grounded by AEGIS® PRO Ring on the drive end and the SR carbon brush on the non-drive end.
- Shaft voltage measured on the drive end using the AEGIS® monitoring ring as the voltage pick-up.
- Most high frequency voltages absent with AEGIS® PRO Ring installed.



AEGIS® PRO Ring Installation Best Practices

The following best practices apply to Double Inverter Fed Generators:

- Both generator bearings should be insulated or ceramic ball
- Slip Ring carbon block brush on NDE in the Exeter Assembly – part of current design.
- AEGIS® PRO Ring should be installed in addition to this system
- AEGIS® PRO Ring Split Ring Design installed on the DE
- AEGIS® Colloidal Silver Shaft Coating DE
- Periodic Maintenance: Every 6 months or as needed:
 - Ensure Slip Ring carbon block system is functioning properly per manufacturer
 - Remove AEGIS® PRO Ring, clean shaft surface, re-apply AEGIS® CS015 and re-install ring.



AEGIS® Shaft Voltage Tester™

Easily and more accurately measure the voltage on a rotating shaft with the AEGIS® Shaft Voltage Tester's™ Shaft Voltage Probe™ Kit which uses a conductive microfiber probe tip to contact the rotating shaft. With the AEGIS® Shaft Voltage Tester™, you can determine if your generator is subject to potentially damaging bearing currents. Visit our website for a complete part list.



AEGIS-OSC-9100MB-W2

Shaft Preparation

Generator shaft must be conductive:

Shaft must be clean and free of any coatings, paint, or other non-conductive material (clean to bare metal). Depending on the condition of the shaft, it may require using emery cloth or Scotch-Brite™. If the shaft is visibly clean, a non petroleum based solvent may be used to remove any residue. Recommended shaft surface finish: Ra 63 or better. If possible, check the conductivity of the shaft using an ohm meter.

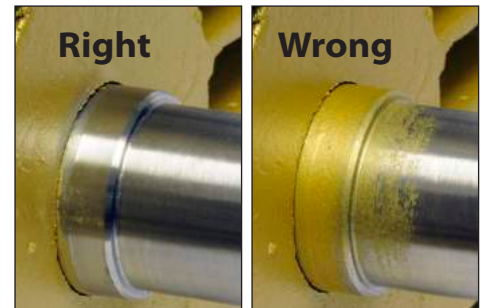

Ohms test:

Place the positive and negative meter leads on the shaft at a place where the microfibers will contact the shaft. Each motor will have a different reading but in general you should have a maximum reading of less than 2 ohms. If the reading is higher, clean the shaft again and retest.



Shaft Preparation

AEGIS® CS015 Colloidal Silver Shaft Coating:

Colloidal Silver Shaft Coating (CS015) is recommended for all applications. The silver coating enhances the conductivity of the shaft and also lessens the amount of corrosion that can impede the grounding path.



1. Heat shaft where the fibers of the AEGIS® Ring will be contacting the shaft surface using a heat gun set on high. Heat surface all around for about 1 minute.
2. Thoroughly stir the silver coating.
3. Apply a layer of the AEGIS® Colloidal Silver Shaft Coating to the area where the AEGIS® microfibers will be in contact with the motor shaft. Apply evenly all around the shaft.
4. Wait for 1 minute and re-heat the area for 30 seconds as before
5. Apply a second coat of CS015
6. Let cool

Note: Although the CS015 can be installed without a heat gun, it is recommended for quicker curing time. Coating will cure at room temperature in 16-20 hours or in 30 minutes at 120-200°C. A heat gun will cure the materials in seconds.

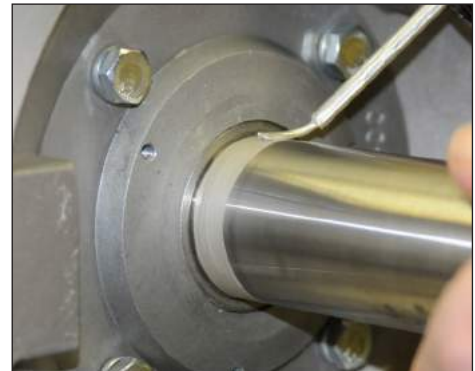

Follow all safety precautions. SDS for CS015 available for download at www.est-aegis.com

AEGIS® PRO Ring Installation

Split PRO Ring (preferred for required maintenance) -

Disassemble PRO Ring by removing screws from the face.

Reassemble PRO Ring on shaft. Take care to prevent fiber damage during installation.

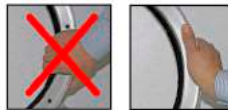

Ensure contact of fiber all around.

Secure to motor with bolt through mounting hardware or custom brackets.

Solid PRO Ring-

Slide ring over the shaft and ensure contact of fiber all around.

Secure using bolt through mounting hardware or custom brackets.



Shaft Conductivity and Maintenance

1. Every six months or as necessary check the turbine shaft for conductivity.
2. Remove AEGIS® PRO Ring from shaft and inspect shaft surface.
3. Clean any corrosion or material from shaft surface to bare metal using solvent and/or fine grit sandpaper.
4. Reapply AEGIS® Colloidal Silver Shaft Coating (CS015) (see procedure on page 6)
5. Inspect AEGIS® PRO Ring and ensure fibers are touching the generator shaft 360 degrees when installed.

AEGIS® PRO Ring - Split

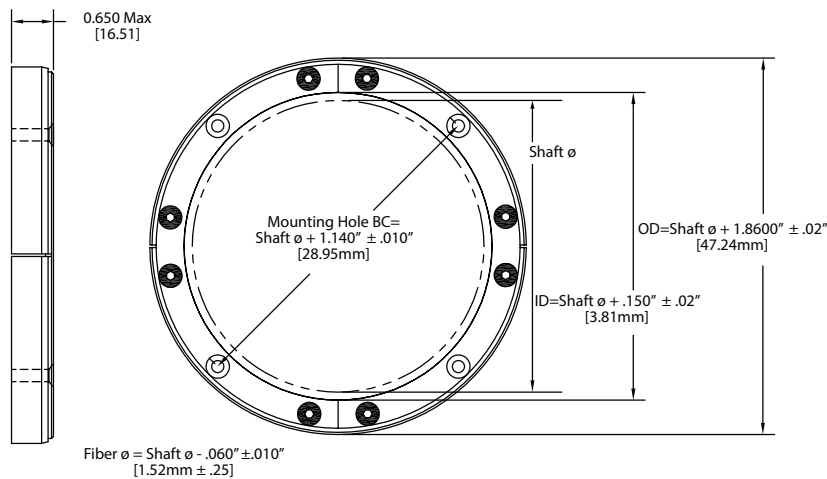

AEGIS® PRO Ring - Solid

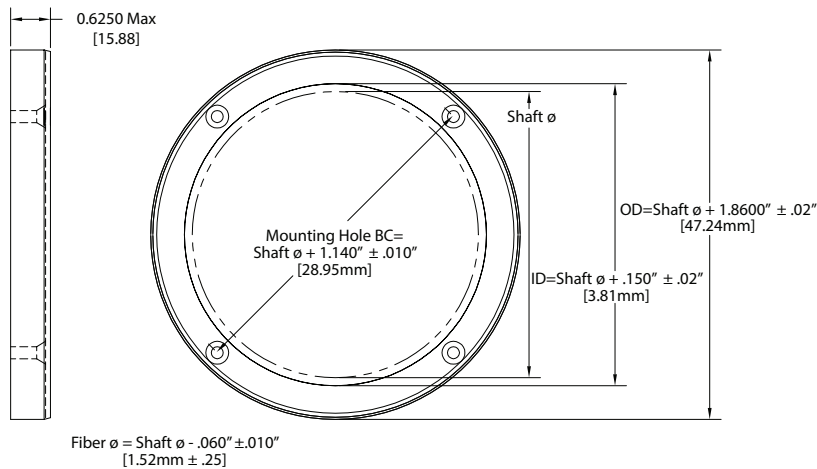

AEGIS® PRO Ring Universal Brackets

Kit includes brackets, four different spacer lengths and hardware for each.





Award Winning Technology



Test Motors for Shaft Voltages

Specially designed for testing motor shafts, the new AEGIS® Shaft Voltage Tester™ Digital Oscilloscope is configured to take shaft voltage measurements right out of the box. This easy-to-use 100 MHz dual channel oscilloscope comes with everything you need to take and capture shaft voltage readings in high-resolution, including a 10:1 probe with special microfiber tips, a probe holder with a magnetic base, and a compact carrying case. With the push of just one button, the scope's screen capture feature saves screen images for analysis and reporting.



For more information visit:
www.est-aegis.com/tester



sales@est-aegis.com | www.est-aegis.com